

1 = DPX<sup>3</sup> 160  
2 = DPX<sup>3</sup> 250

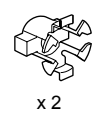

x 2

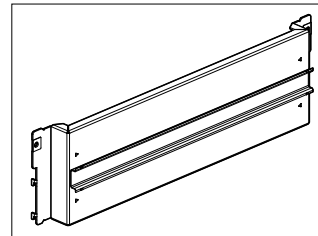

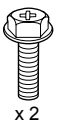

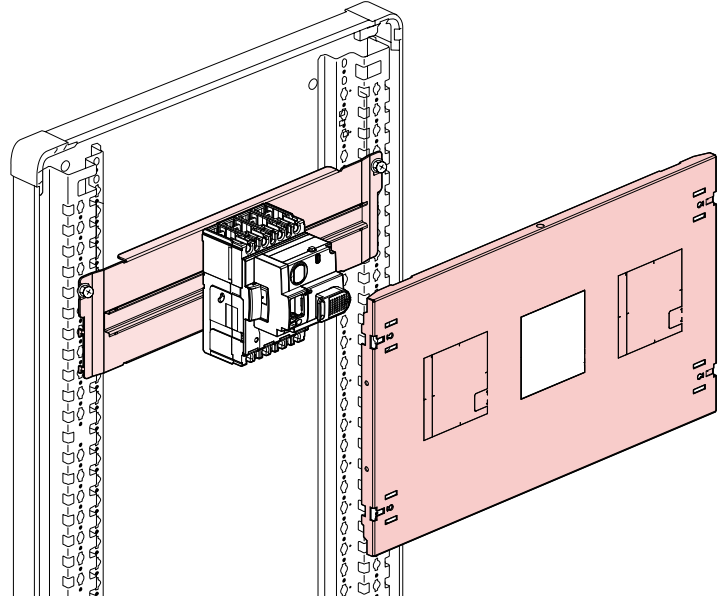
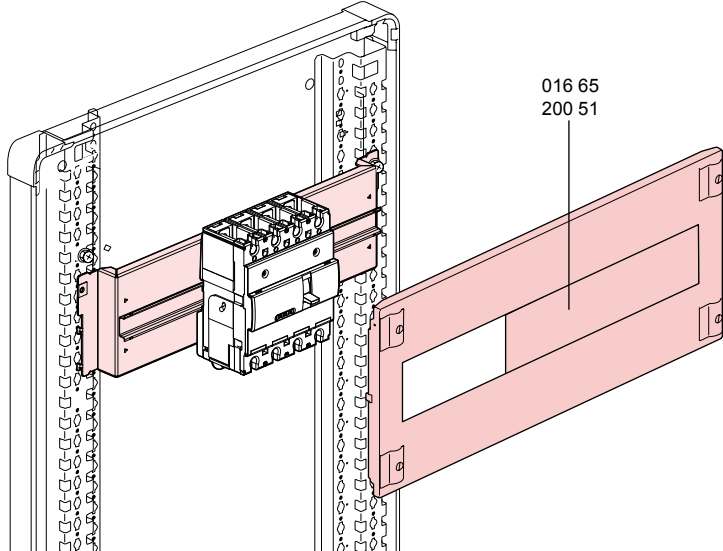

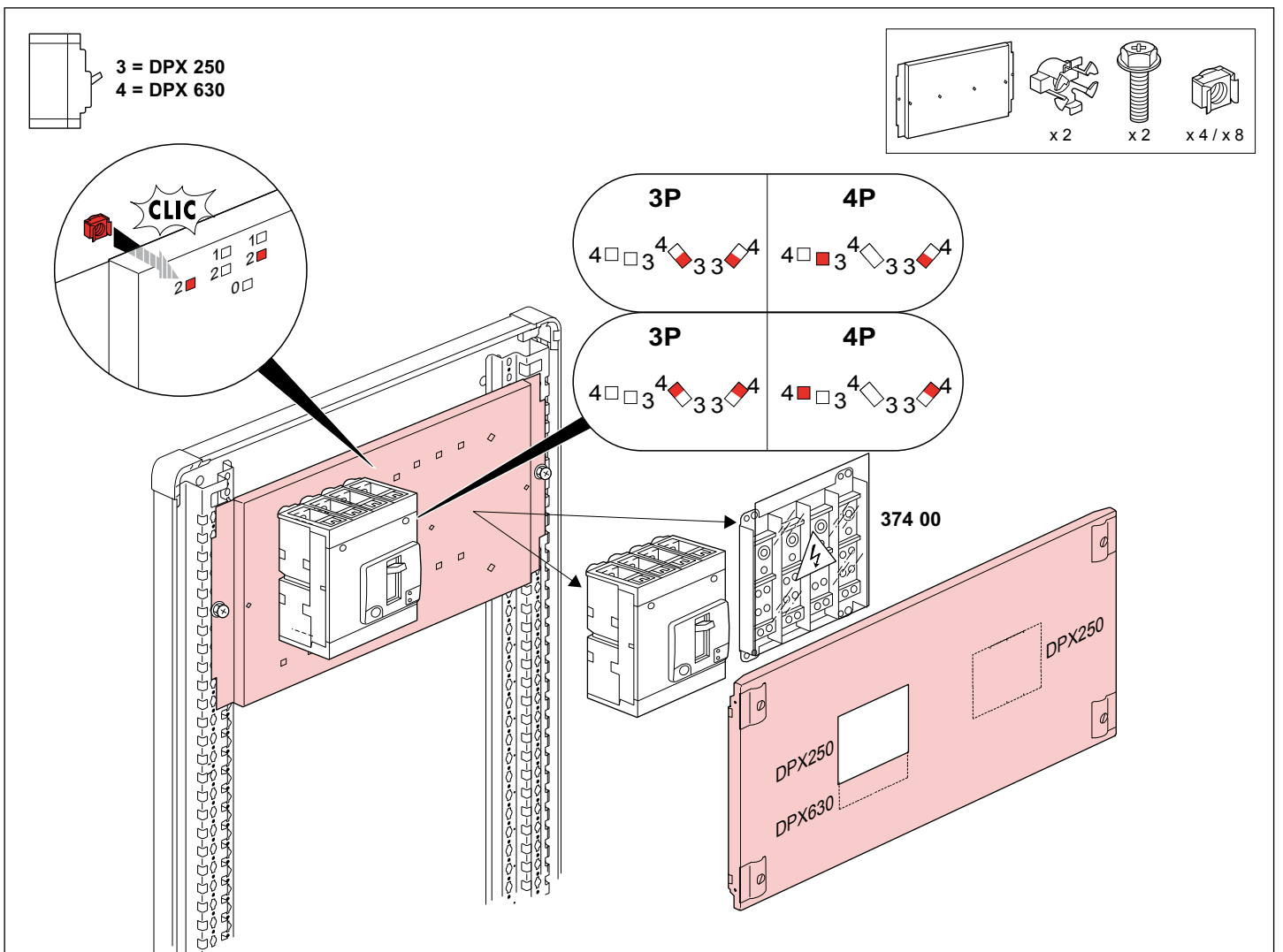
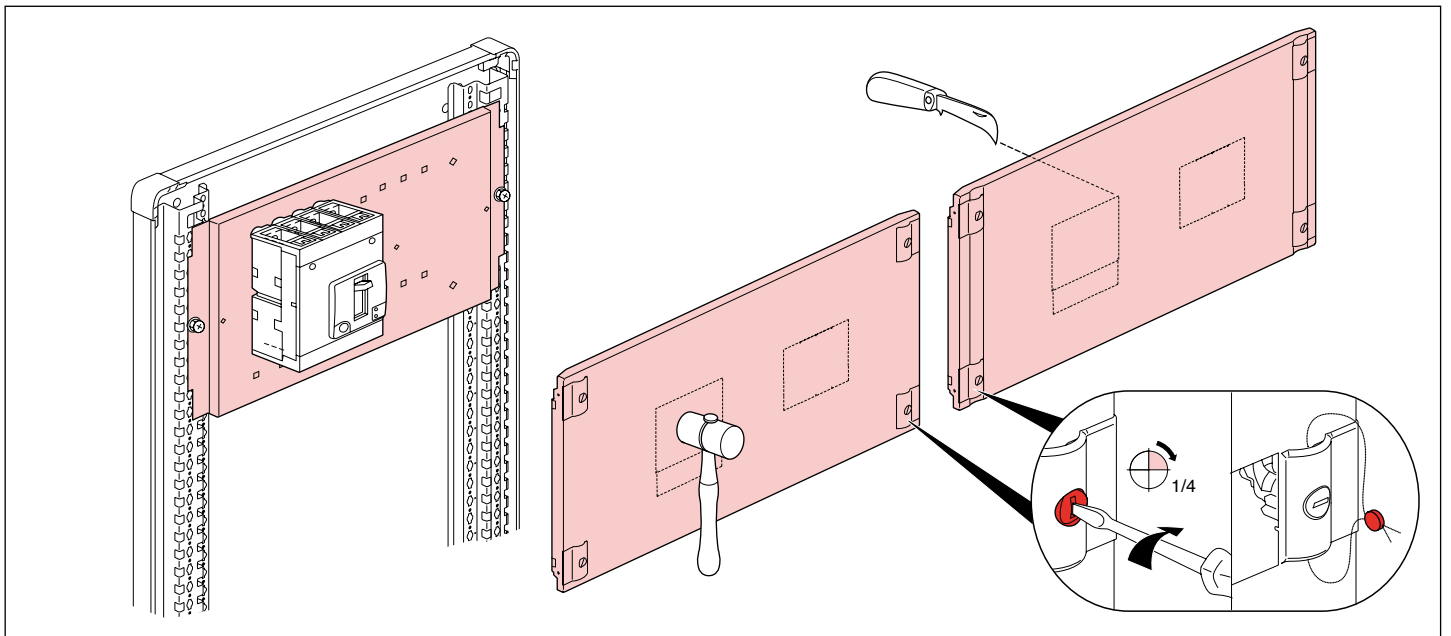

x 2

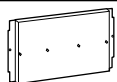

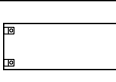
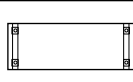





	202 11		203 10	203 60	300 mm
	202 09		203 09		300 mm
	202 17		203 18		300 mm

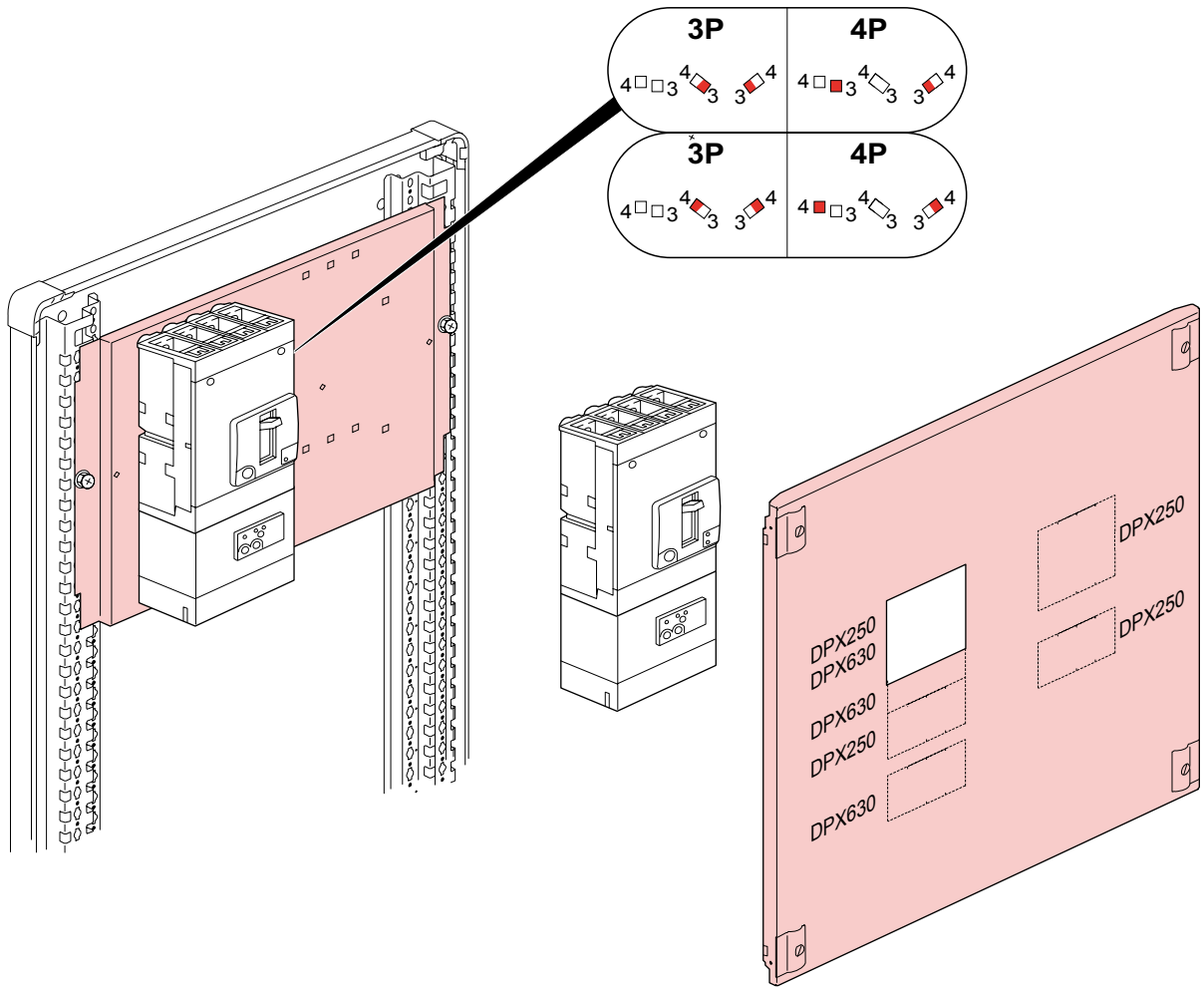
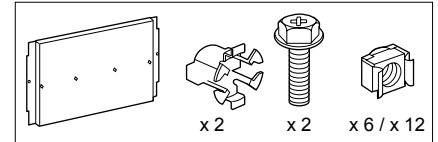

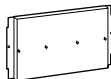
						
	202 21 202 20	DPX 250 / 630	x 1 x 2	203 21 203 20	203 71 203 70	400 mm 400 mm
	202 28	DPX 250 / 630	x 1	203 28		400 mm

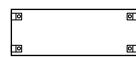
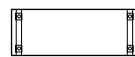
3 = DPX 250  
4 = DPX 630



						
	202 23	DPX 250 / 630	x 1	203 23	203 73	600 mm
	202 22		x 2	203 22	203 72	600 mm
	202 29	DPX 250 / 630	x 1	203 29		600 mm